

INSTALLATION INSTRUCTIONS

IFW 66 SERIES INFRA RED WARMER

ELECTRICAL SPECS:

VOLTS	WATTS	AMPS	HERTZ	PHASE	NEMA
120	250	2.0	60	1	5-15
240	275	1.1	60	1	6-15

Warmer should be installed by an experienced electrician.

U.L. REQUIREMENTS:

- A. Wires of warmers to be connected to 75°C wire.
- B. Wires are to be installed in conduit.
- C. Warmers are not to be installed any closer than 1" from a wall.
- D. Warmers must be **at least** 16" above a combustible surface.

HOW TO INSTALL:

Numbers in parentheses correspond to numbers in callouts.

1. Remove the two screws from the canopy and pull off the canopy.
2. Run the cord (1) up through the canopy, through the strain relief and the threaded nipple. Tighten the strain relief. Cut the cord to the desired length.
3. Mount the strap to the electrical outlet box with two screws provided.
4. Wire the warmer leads to the outlet box leads.
5. Attach the ground wire to the ground hold in the strap with the green ground screw.
6. Re-attach the canopy with the two screws.
7. Screw the bulb (4) into socket.

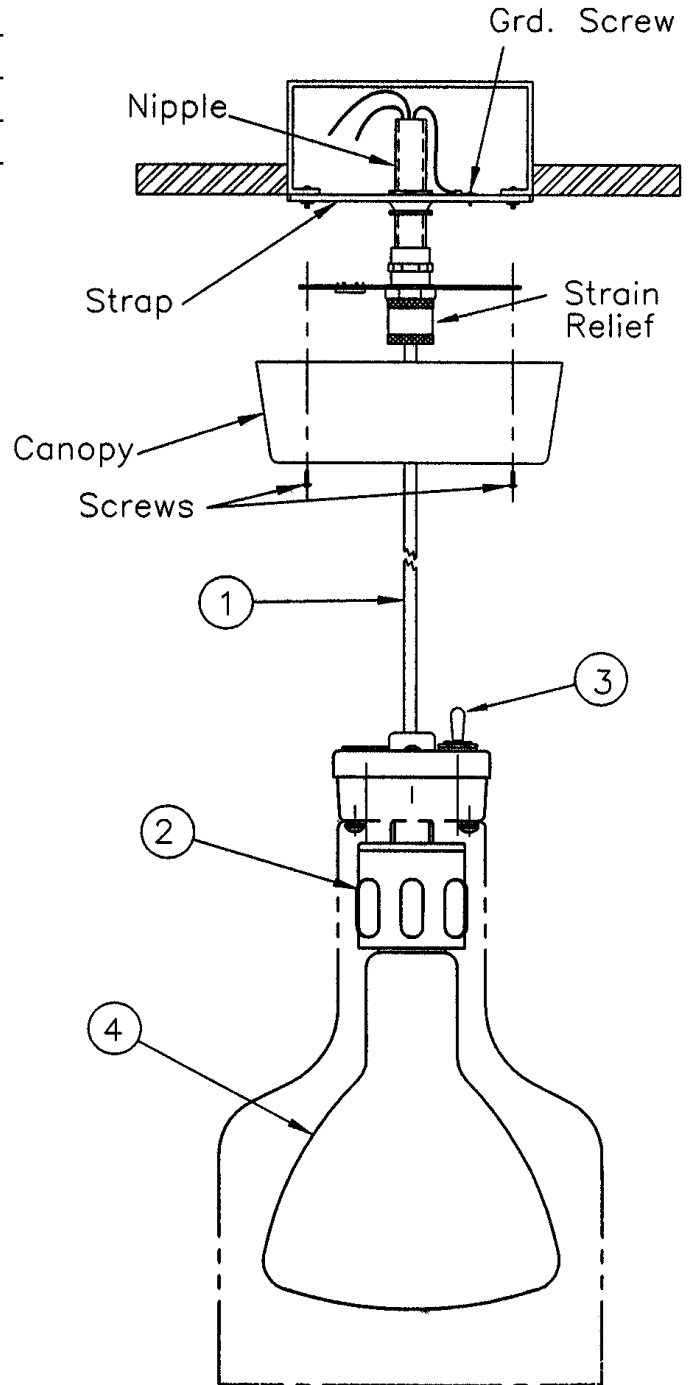

Decorator Hood IFW 66 Series	FL-2194
Rev. 4 (05/06)	Page 2 of 2

INSTALLATION INSTRUCTIONS

IFW 66 SERIES INFRA RED WARMER

HOW TO INSTALL HOOD:

You will need a Phillips head (preferably magnetic) screwdriver with a long neck.

1. Slide the hole in the top of the hood over the socket.
2. Look inside of the hood and line up two (2) hood mounting holes with the holes in the arm assembly.
3. Put the screw provided on the screwdriver tip and screw loosely into one hole and then into the other; then tighten both screws.
4. Screw lamp into the socket.

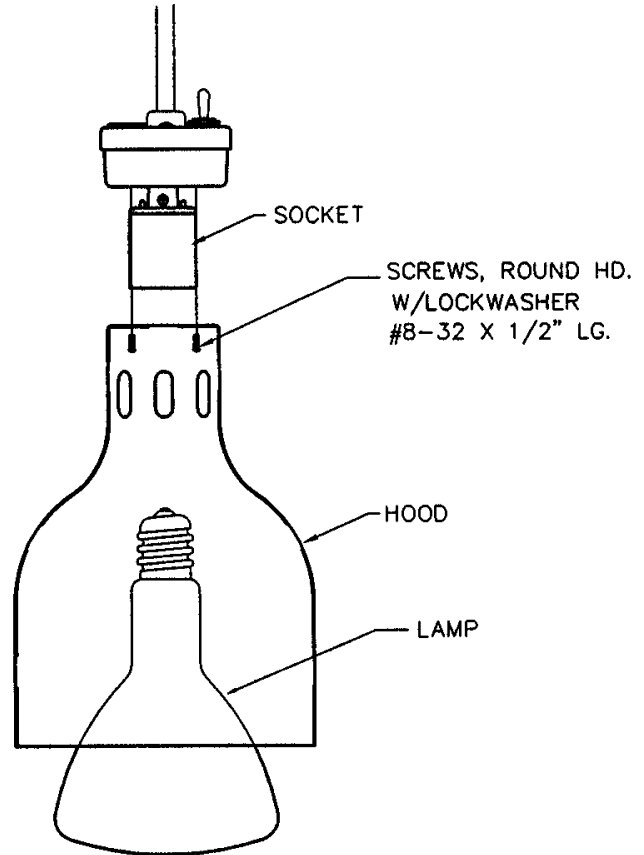

REPLACEMENT PARTS:

ITEM	DESCRIPTION	PART NO.
1	Cord Assembly	0810-142
2	Socket Assembly	0822-037
3	Switch (120V)	0820-002
3	Switch (240V)	0808-122
4	Bulb, Red (120V)	0820-001
	Bulb, White (120V)	0820-033
	Bulb, Red (240V)	0820-014

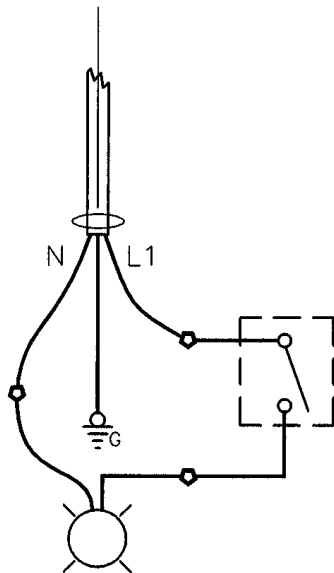

WIRE FOR 120V

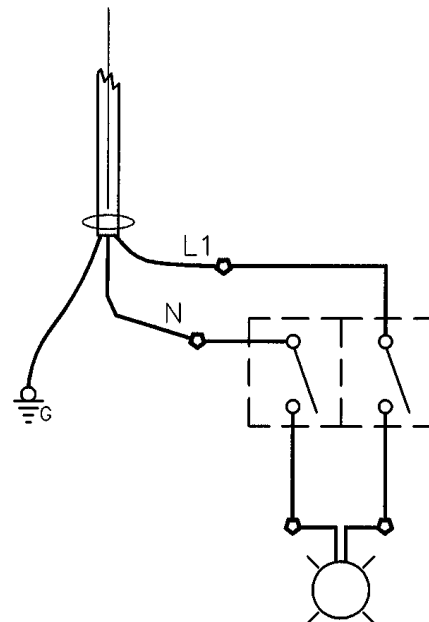

WIRE FOR 240V